

CLASSE 300EOS

WITH
Netatmo



The Evolution Of Smart.

bticino

A Group brand | **legrand**

CLASSE 300EOS

THE EVOLUTION OF SMART



Video door
entry system



Management
with smartphone



Voice
control



Smart
Home



Smart
Security



Classe 300EOS with Netatmo is the new 2 wires / Wi-Fi handsfree connected video internal unit with built-in Amazon Alexa voice assistant. Using the Home + Security App, in addition to video door entry calls, it is also possible to manage the devices of the Netatmo security range, creating a simple and fast Smart security system.

CLASSE
300EOS | WITH Netatmo

Change your idea of a video internal unit.





The smart vision of the home.

Distinctive design to meet the needs of contemporary living. Vertical and super slim. With its clean and modern design, it gives every type of home an innovative look, and offers a unique user experience.



Vertical display and curved shape:
a disruptive and modern design,
but also understated.



5" Touch Screen

Vertical display
for a better view
of the caller



Face detection

Automatic centring of the
subject on the display



Horizontal display

Double "tap" the display
to view the image
in landscape format



Curved shape

The shape of a welcome:
a "welcoming effect"
for residents and guests.



VIDEO DOOR ENTRY SYSTEM



Advanced interface.



Intuitive use
For simple smartphone-like gestures (swipe function)



Quick tips
To guide you and suggest in a dynamic way

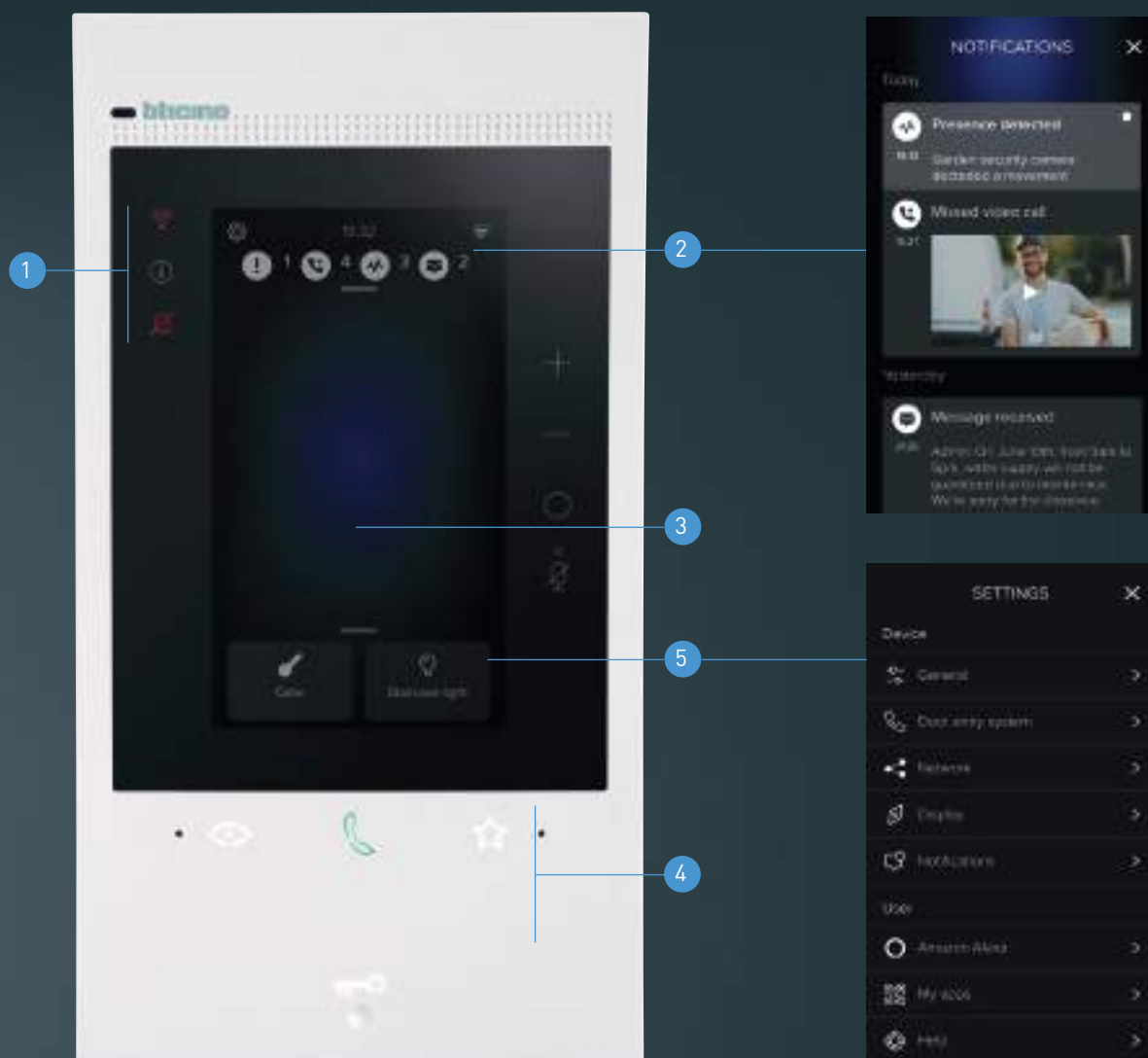

- 1 Led**
 - Wi-Fi connection status
 - Presence of notifications
 - Ringtone exclusion

- 2 Notifications**
 - Missed calls
 - Messages
 - System information

- 3 Suggestion area**
 - Guided configurations
 - System information
 - Last notification
 - Useful tips

- 4 Door entry functions**
 - Activate the camera
 - Answer the call
 - Favourite functions
 - Activation of the electrical door lock

- 5 Favourite actions**
 - 2 quick actions
 - Favourite menu

Always aware with the Home + Security App



Home + Security

The best App for a safe home

Alerts and notifications for incoming calls, motion and people detection, event information and door lock management with a simple and intuitive interface.



Answer the calls,
activate the electrical door locks,
activate the cameras and display
the timeline of the events

Manage up to 20 homes
with your single account



Home + Security

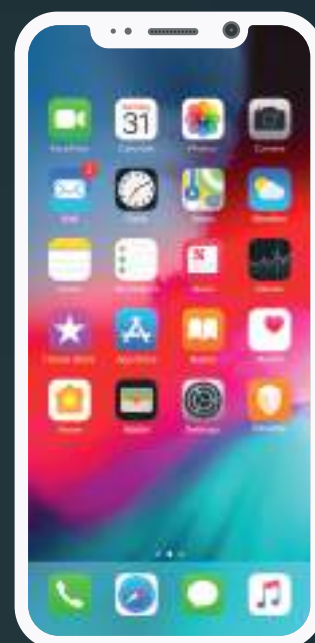

Incoming call
Receive notification
when someone
is calling

See who's calling
Answer the call and
open the gate for
the courier

Check the events
Check who called you
and if they left you
a message

Quick actions

- Activate the electrical door locks
- Activate the timed staircase lights
- Call home / Intercom
- Activate the cameras
- Manage the video door entry answering machine

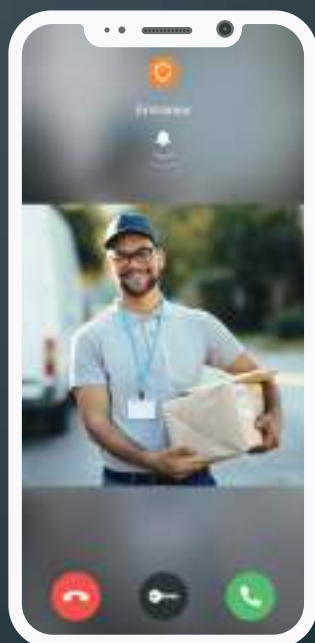
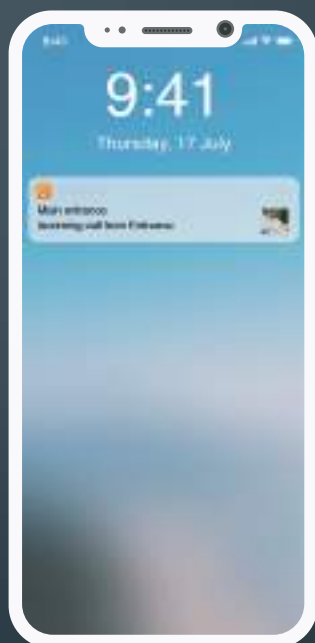

Security enhancement with integration of Netatmo devices

Video door entry system and security. Together.

Video door entry system



Main entrance
Incoming entrance call.

Security



Secondary entrance and interiors
Smart Outdoor Camera with Siren and movement detection. Smart Indoor Camera with face recognition.

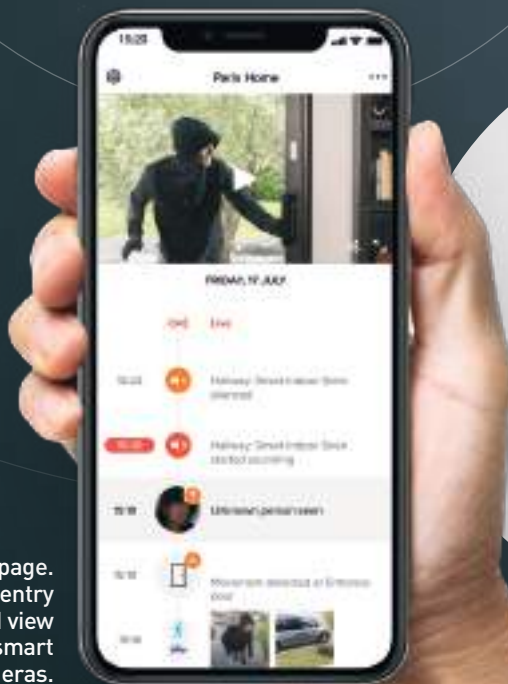

A single App with an intuitive home page. It allows you to answer video door entry calls, activate the door lock and view images from Netatmo smart outdoor and indoor cameras.



Professional opportunity: offer your services as an installer of simple smart security systems.
Business opportunities: access to a catalogue of smart and easy-to-install security devices.

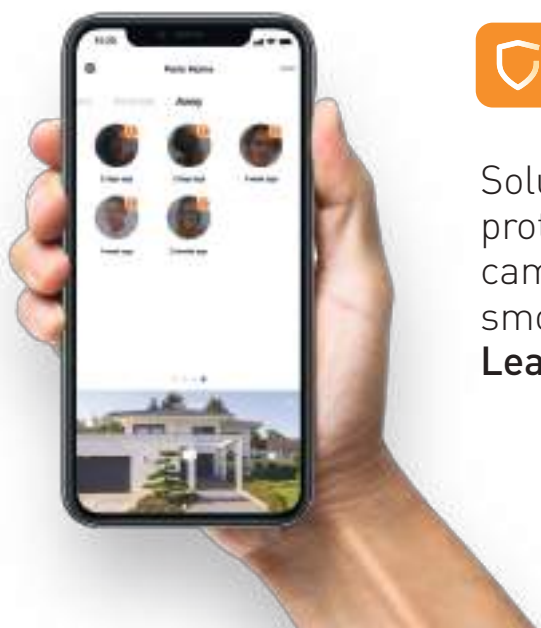

Home + Security
The best App for a safe home.

Solutions for a smart and complete protection of your home: security cameras, alarms, opening sensors, smoke detector...

Leave your home without worries.

WITH
Netatmo

**Netatmo solutions natively integrated
in the Home + Security App**



Smart Outdoor Camera



Smart Outdoor Camera with Siren



Smart Indoor Camera



Smart Door and Window Sensors



Smart Video Doorbell



Smart Indoor Siren



Smart Smoke Alarm



Smart Carbon Monoxide Alarm

ALEXA BUILT-IN



The first video internal unit with built-in Alexa

Enjoy the full Alexa experience interacting with all its functions, such as:
Custom routines - Play Music - Smart Home
To set the clock alarms - Memos and
video door entry functions.

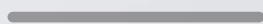



Add any compatible “works with Alexa” devices, to offer your customers an increasingly Smart home.



“Alexa, open the gate”



“Alexa, what’s the weather today”



“Alexa, I go out”

NOTE: Alexa is not available in all languages and Countries.
Alexa features and functionality may vary by location.



2 wires standard installation

Wall mounted installation using the bracket supplied with no need of masonry works. Built-in Wi-Fi connectivity and same installation rules as for the 2 wires video internal units.



No changes to your working habits.
Same installation rules as for the 2 wires video internal units.

Forget complex installations and configurations of Ethernet networks, and continue to enjoy the **simplicity of 2 wires solutions**. Everything stays the same thanks to the Wi-Fi technology integrated in the video internal unit.



Simple and intuitive configuration

The configuration requires no IT skills. You must only configure the classic 2 WIRES system parameters (entrance panel and internal unit SCS addresses, etc.). Your customer manages all the configurations of the Wi-Fi network and the App independently and intuitively. If necessary one can follow the information on the video door entry display and inside the Home + Security App menu.



Installation, connection of the two BUS wires, configuration of the main system parameters: job done!

Immediate and simple to associate

After the App download, a guided procedure allows the association between smartphone and Classe 300EOS.



A few simple guided steps to complete the association of the App with the video internal unit

1
After downloading the H+S App to your smartphone from the store or using the QR code on the video internal unit, simply select «**START CONFIGURATION**».



2
Select the Classe 300EOS device in the H+S App menu.

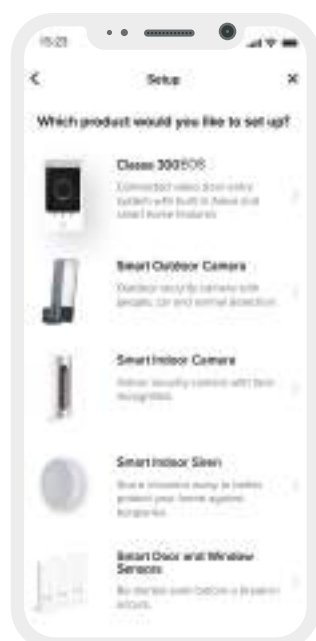

3
The video internal unit has a QR Code, which can simply be framed in the H+S App to complete the association within the same Wi-Fi network.

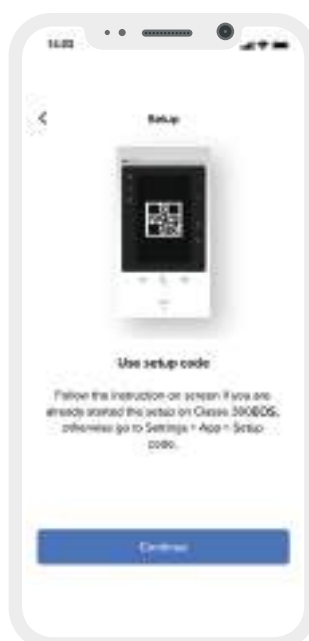

4
After the association, the device is configured and ready for use.

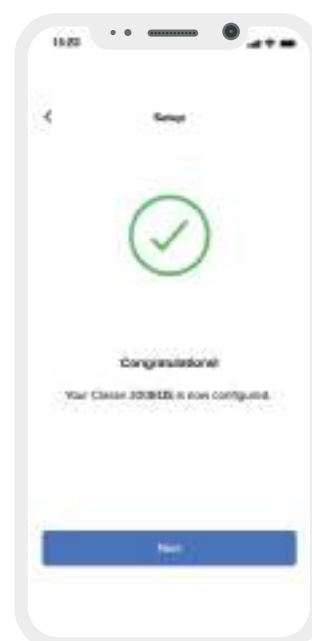

The connection to the dedicated Cloud totally and safely automates the configuration on the home network (you do NOT need to configure your router). The video internal unit transfers all the configuration of the 2 WIRES video door entry system (cameras, door locks, activations etc.) to the App. From Smartphone, using the App, you can always display the mobile devices associated to it and decide which to disconnect or cancel at any time.

Suitable for all home environments



FOR THE VILLA OR FOR ONE&TWO-FAMILY CONTEXT

The easiest way to make your home safer.



INSTALLER INFO

Built-in connectivity for constant connection with the home.

Complete the system with Netatmo security solutions: outdoor and indoor cameras, alarms, opening sensors, smoke detectors, for a simple, smart and complete protection of the home.

One single App (Home + Security) for the video door entry functions and the security of the home.

No extra work for the installer; easier to use for the end user.

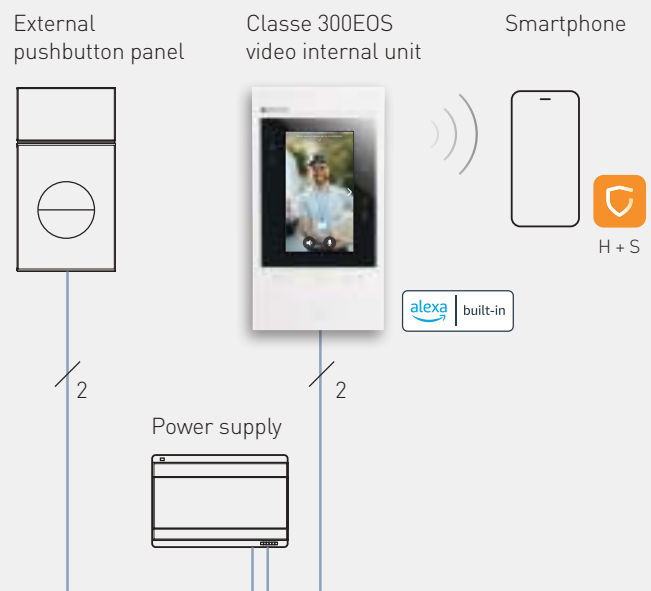



FOR APARTMENT BLOCK OR MULTI-FAMILY CONTEXT

Install, configure and activate the system on location. All that your customer will then need to do, is to associate the H + S App to the system using their smartphone.

REAL ESTATE AND INSTALLER INFO

Alexa ready apartments, for a first level Smart Home.

Preparation of the single apartment system for future expansions using Netatmo security solutions. Leaving to the end user the freedom to customize their home even at a later date.

One single App (Home + Security) for the video door entry functions and the security of the home.

Flexible solution, suitable for every context and adaptable to every customer.

Warning: in multi-family systems (apartment blocks) you need the extra power supply of the CLASSE 300EOS video internal unit (install 1 extra power supply 346020 for each Classe 300EOS).

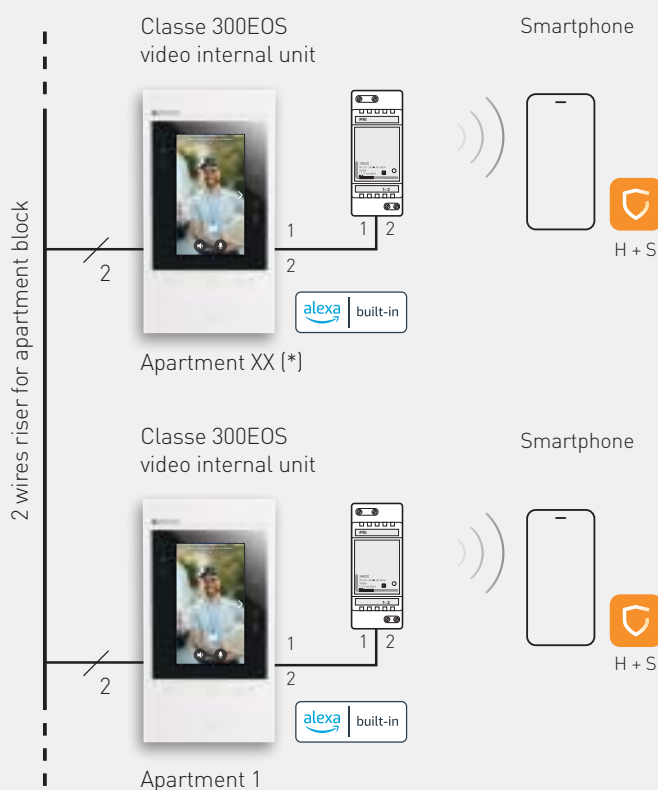

NOTE: for the sizing of multi-family systems refer to the General Installation Standards of the 2 Wires System Technical Guide.

Classe 300EOS with Netatmo

Front view

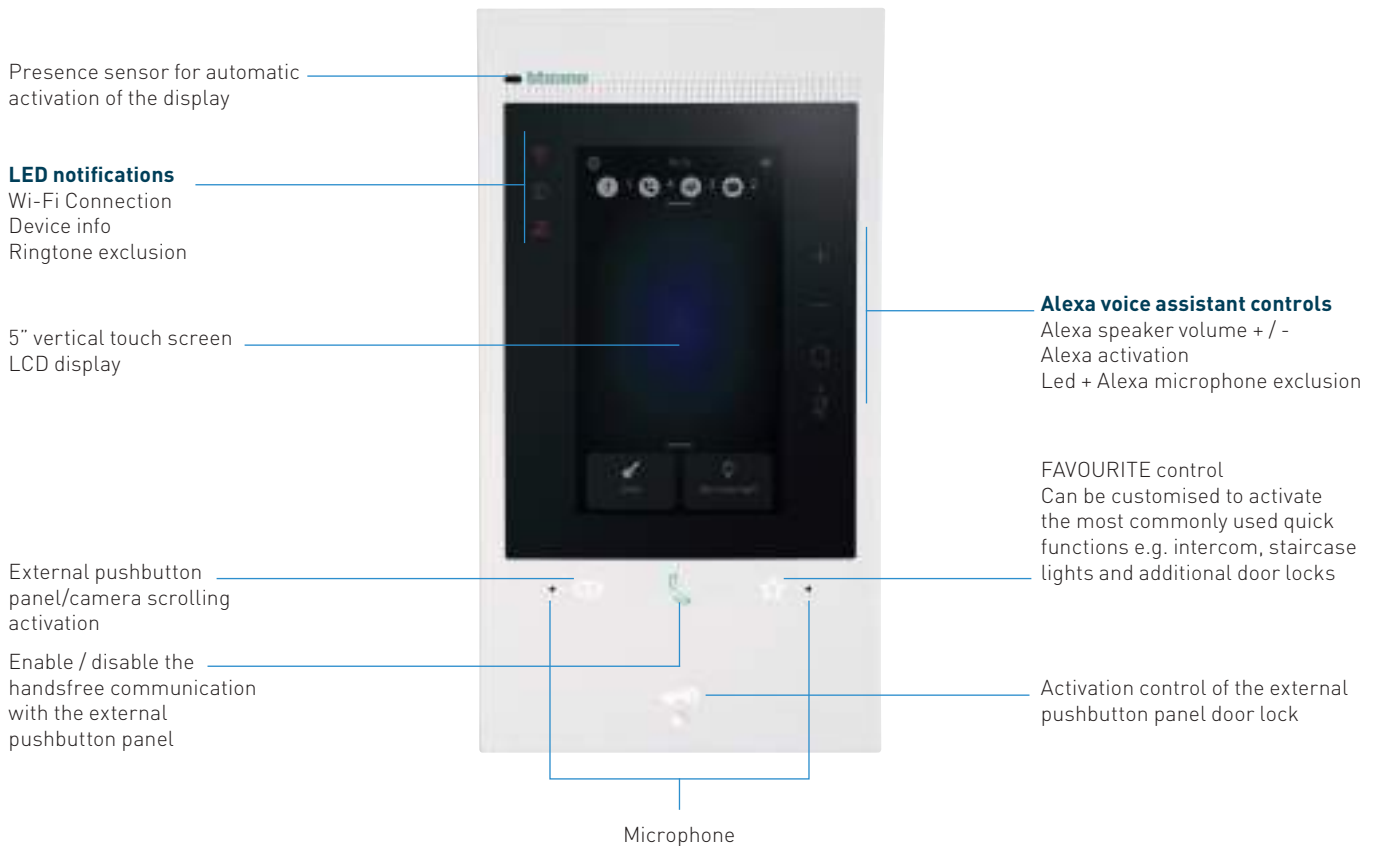

Back view

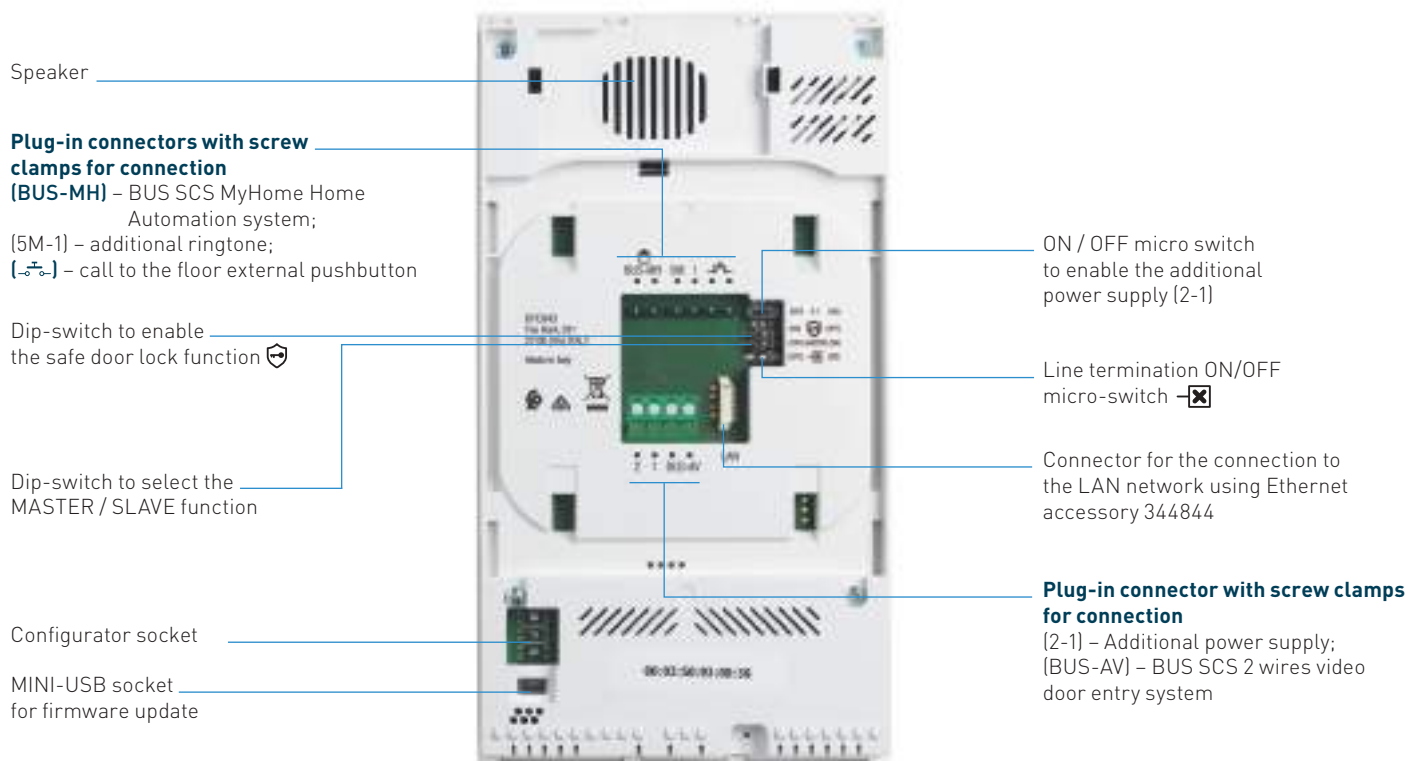

Features and functions



344842

MAIN FEATURES

✓	5" vertical touch screen colour LCD display
✓	Handsfree communication
✓	White finish
✓	Wall mounted installation using the supplied bracket
✓	Available in Kit - 363915

AVAILABLE FUNCTIONS FROM VIDEO INTERNAL UNIT

✓	Activation of the electrical door lock
✓	Staircase light activation
✓	Entrance panel/scrolling activation
✓	Intercom
✓	Floor call
✓	Professional Studio (Office)
✓	Video door entry answering machine
✓	Master / Slave
✓	Safe door lock
✓	Wi-Fi connectivity
✓	Built-in Alexa voice assistant
✓	Notification management
✓	Quick link - Favourite / most used functions
✓	Favourite control
✓	6 available ringtones



AVAILABLE FUNCTIONS FROM HOME + SECURITY APP

✓	Answer a video door entry system call
✓	Activation of the electrical door lock
✓	Entrance panel/scrolling activation
✓	Staircase light activation
✓	Activation and monitoring of the smart Netatmo cameras
✓	Management of the Netatmo Security devices (smoke sensor, burglar-alarm siren, opening sensor...)
✓	Video door entry answering machine
✓	Intercom call from smartphone to video internal unit
✓	History of the events

Classe 300EOS with Netatmo Catalogue



344842



344844



346020

Item	CLASSE 300EOS WITH NETATMO CONNECTED VIDEO INTERNAL UNIT
344842	<p>2 wires/Wi-Fi handsfree connected video internal unit with built-in Amazon Alexa voice assistant, 5" vertical touch screen LCD display and video door entry answering machine. It has a physical key for door lock release and capacitive keys for the control of the main video door entry functions: handsfree communication, entrance panel activation / camera scrolling and Favourite key (can be configured to activate the quick actions most frequently used – e.g. additional door locks, staircase light control, intercom). There are notification LEDs for: Wi-Fi network connection status, info / notifications and call exclusion.</p> <p>It is possible to easily interact with the built-in Alexa voice assistant, either using the dedicated capacitive keys or with your voice, and activate several functions, such as the video door entry functions, Smart Home, scenarios, reminders etc. Using the touch display, it is possible to access the notification list, as well as your favourite door entry, security and Smart Home controls (if any). Possibility of voice communication with the switchboard - if present in the system - after a specific call. The device must be configured by physically connecting the configurators, or using the menu, which will give better possibilities of customisation of associated functions and texts.</p> <p>Thanks to the Wi-Fi connection, you can associate the video internal unit to the Home + Security App (available for Android and iOS). The App allows to use the main video internal unit functions (receiving calls, door lock release, display of the event timeline and activation of the entrance panel/camera cycling). Through the Home + Security App, it is also possible to manage the products of the Netatmo security range (outdoor and indoor cameras, door and window sensors, indoor siren and smoke detector).</p> <p>This allows you to quickly and easily create a Smart security system. The device also allows to create and manage Smart Home functions, using the wired SCS BUS solution or the Zigbee solution, without the need for adding dedicated gateways. Wall mounted installation using the supplied bracket Possibility of Wi-Fi connection or using RJ45 ethernet cable with the dedicated accessory 344844.</p>

Item	ETHERNET ACCESSORY
344844	Accessory cable for the wired connection of the Classe 300EOS video internal unit using an RJ45 Ethernet cable. To be purchased separately.
Item	2 DIN ADDITIONAL POWER SUPPLY
346020	Additional 2 DIN power supply to be used to supply the connected CLASSE 300EOS video internal unit (344842) locally, when required.



KIT



363915

Linea 3000 external pushbutton panel with RFID door lock release key card set

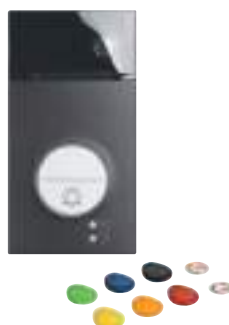

Classe 300EoS with Netatmo



Item	KIT LINEA 3000/CLASSE 300EoS WITH NETATMO
363915	<p>One-family handsfree kit with Classe 300EoS handsfree connected video internal unit and LINEA 3000 pushbutton panel in black finish.</p> <p>2 wires/Wi-Fi handsfree connected video internal unit with built-in Amazon Alexa voice assistant, 5" vertical touch screen LCD display and video door entry answering machine.</p> <p>It is possible to easily interact with the built-in Alexa voice assistant, either using the dedicated capacitive keys or with your voice, and activate several functions, such as the video door entry functions, Smart Home, scenarios, reminders etc. Thanks to the Wi-Fi connectivity, you can associate the video internal unit to the Home + Security App (available for Android and iOS). The App allows to use the main video internal unit functions (receiving calls, door lock release, display of the event timeline and activation of the entrance panel/camera cycling). With the Home + Security App, it is also possible to manage the products of the Netatmo security range (outdoor and indoor cameras, door and window sensors, indoor siren, smoke detector). This allows you to quickly and easily create a Smart security system. The device also allows to create and manage Smart Home functions, using the wired SCS BUS solution or the Zigbee solution, without the need for adding dedicated gateways.</p> <p>LINEA 3000 pushbutton panel with black finish zamak front cover, wide angle colour camera and proximity reader and with a kit of coloured key cards and two clear discs for door lock release.</p> <p>Can be wall or flush installed with specific accessories: (350020) flush mounted box and (343063) flush mounted accessory - to be purchased separately.</p> <p>Can be fitted with rainshield (343053) - to be purchased separately. The pushbutton panel has a protection index IP54- protection index against mechanical impact IK10.</p>

Item	KIT COMPOSITION	Quantity
343093	LINEA 3000 pushbutton panel	1
344842	CLASSE 300EoS video internal unit	1
346050	6 DIN SCS power supply	1
346250	Door lock relay accessory	1
348260	Set of coloured door lock release key cards	1
348261	Set of door lock release clear discs	1



Dimensional data

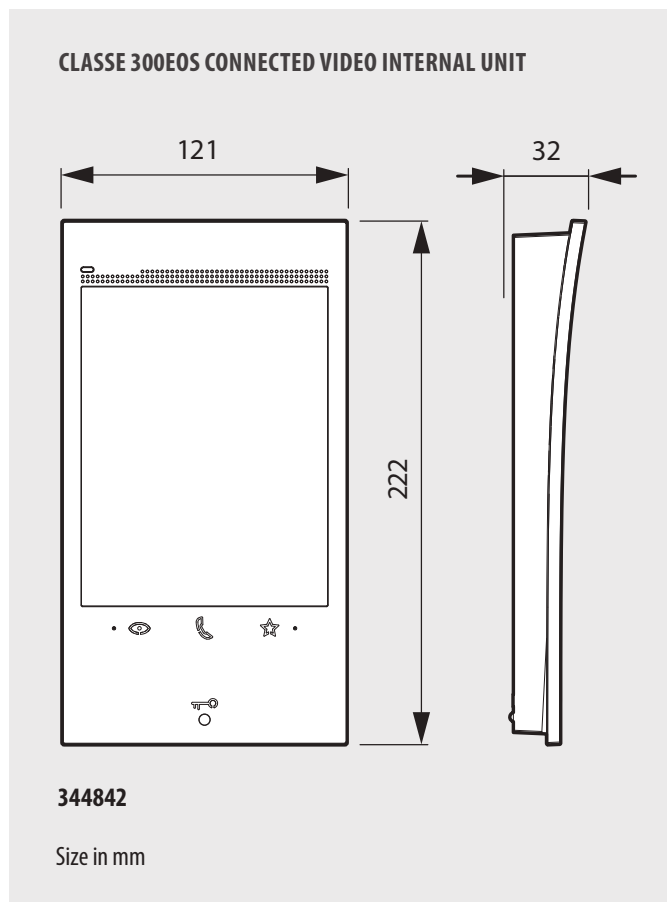



Legrand (S) Pte Ltd

17 Neythal Road,
Singapore 628582
Tel: +65 6416 1660
Fax: +65 6416 1580

www.legrand.com.sg
www.bticino.it

BTicino SpA reserves at any time the right to modify the contents of this booklet and to communicate, in any form and modality, the changes brought to the same.

SEA 22B27 - Apr 2022